

## **Pt100**

### **Objectives**

1. In depth study of a specific sensor
2. Know that there are norms for sensors
3. An example of a transfer function of a measurement
4. Know that the behavior of a measurement also influences the control parameters PID
5. Know that there are specific problems with each type of sensor
6. Know that there are problems with the transmission of the signal

## **1 Measurement of temperature**

There are different physical properties that are temperature dependent and thus can be used to measure temperature. There are

1. liquid thermometer: expansion of the fluid
2. thermocouple thermometer: in this case the thermo-electric effect, Seebeck effect, is used. This effect occurs when two different metals are connected together. If there is a temperature difference over the connection, a difference in potential will be generated. These sensors are relatively cheap and can be used to measure very high temperatures. The biggest disadvantages are the non linear relation the temperature and tension and the sensitivity.
3. metal-resistance thermometer: A resistance is temperature dependent, They have a positive temperature coefficient. This type is very stable, precise and can be reproduced in a large temperature range. It has also a linear characteristic in a large temperature range. The disadvantages are a small absolute resistance and a large heat capacity making the response time on temperature changes quite large. This type is also called RTD (Resistance Temperature Detector).
4. semi conductor thermometer: In this class you can find two types of sensors the NTC (Negative Temperature Coefficient) and the PTC (Positive Temperature Coefficient). The change in resistance due to changes in temperature are large. Because of the large nominal resistance, the resistance of the connection wires are negligible. The biggest drawback is the non linear behavior of this type of sensors. They can only be used in a small temperature range and are mechanically vulnerable. The current used to measure will create an undesired heating up of the sensor.

Figure 1.1 below gives compares the temperature characteristics of an RTD and a thermocouple. You can clearly see that an RTD has a linear characteristic in this temperature range whereas the thermocouple is quite non-linear.

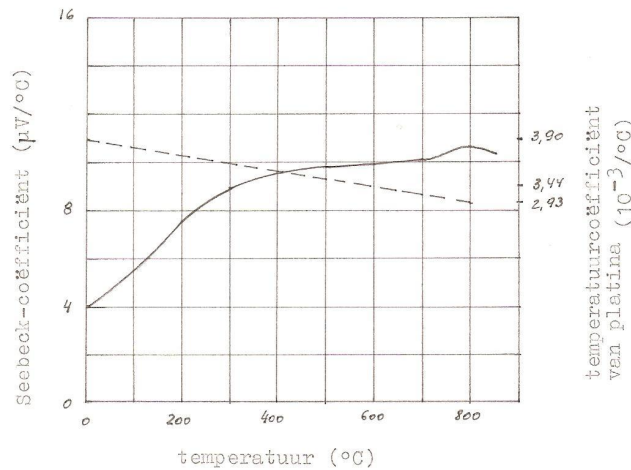

Figure 1: seebeckeffect

## 2 Pt100

A conductor is a material in which the electrons of the outer orbit of the atom are less bonded. If the energy of the material is increased, for example by heating up, the atoms will move (vibrate) more and more and at a certain moment these electrons can leave their orbit and move freely in the space between the atoms. The higher the temperature the more the atoms move and the more difficult it is for the electrons to move around in the space between the atoms, because there is less space in between them. You could say 'The resistance to move around has increased.' This in fact means that the resistance of the material has increased. So this tells that there is a relationship between temperature and resistance. It is this relationship that is used to measure temperature.

This relationship is given by

$$R(T) = R(T_0)(1 + \alpha\Delta T)$$

In the following table gives a idea of the values for resistivity and temperaturecoefficient. (One can find these values on internet or literature but they are always a little different from source to source.)

<i>metal</i>	<i>resistivity</i> (10 <sup>-8</sup> ohm/m)	<i>temperaturecoefficient</i> (10 <sup>-3</sup> /K)
gold	2,35	3,98
copper	1,67	4,33
nickel	6,84	6,75
platinum	10,6	3,92
tungsten	5,65	4,83
silver	1,59	4,1

To have a correct measurement means that there are no system errors. One of the basic conditions is that the nominal resistance of the sensor is very high. The higher this resistance the higher lower the influence of the resistance of the connectionwires.

You can see in the table above that tungsten has a very high resistivity but is only used for very high temperature ranges.

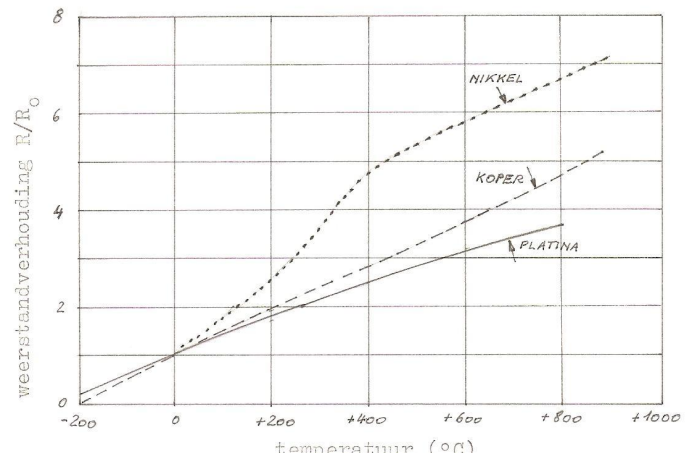

Figure 2: resistance in function of temperature

Copper is only used for ranges up to  $250^{\circ}C$ . Because of the low resistivity the length of the sensorwire has to be very large. On the other hand is this a cheap material and a its behavior is very linear.

Most of the RTD (Resistance Temperature Detector) are made by using nickel or nickelalloy or platinum. these materials are available in a very pure form, can be produced in very thin wires. They also show very linear and reproducibel behavior. For a number of reasons platinum is the most widely used. The behavior of Pt-sensor is accurately described by an analytical function for a broad temperature range.It is chemical inert and it measures correctly in a temperature range from  $-200^{\circ}C$  to  $+850^{\circ}C$ .

Nickel and nickel-iron alloy is used because of their high temperaturecoefficient,they are relativly cheap end easy to process.The biggest disadvantage however is the small temperature range it can be used in.

A more modern material that is used after the processing technique (thin film) was optimized, is iridium. Its advantages are

- high temperaturecoefficient
- good dilatationcoefficient accordngly to its substrate ( $Al_2O_3$ )

### 3 Design

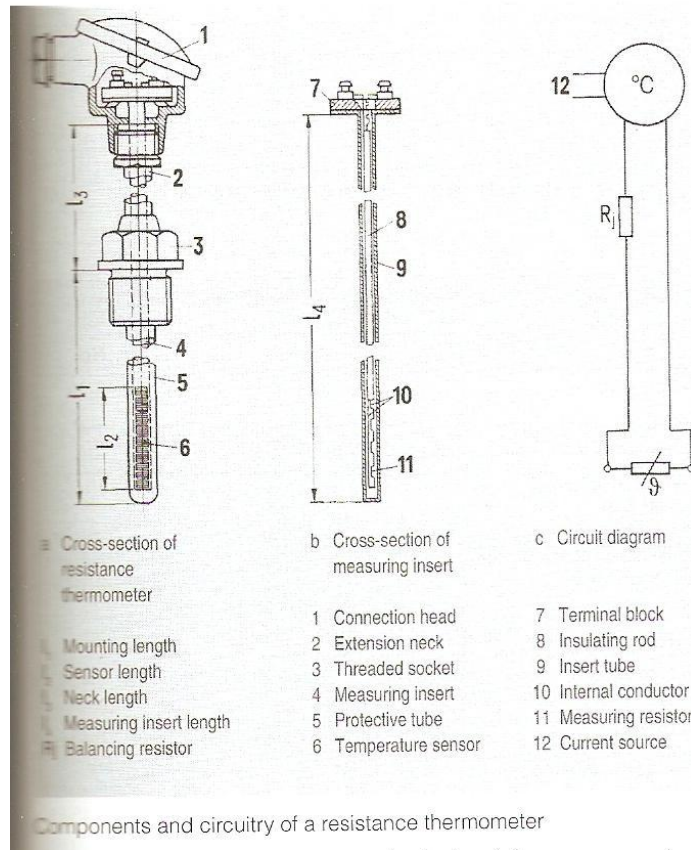

Figure 3: design of an RTD

A lot of different designs for RTD can be found on the market.

Usually a thin wire is wrapped around an inert substrate. This wrapping has to be done in such a way that there are no mechanical tensions in the material because they would introduce measurement errors. Usually they are wrapped in a bifilair way to decrease magnetic fields which once more create measurement errors. Once the wire is wrapped, a protective coating is placed around this structure to avoid unwanted ambient influences like vibrations, moisture,....

The dilatation coefficients of the resistance and the coating have to be precisely tuned into each other or there will occur mechanical tensions.

The supply wires must be made from very good conducting material so their resulting resistance is very low.

Nowadays is the most modern way to produce RTD thin film technology.  
 For industrial applications the thermometer is build into a protection fitting.  
 Those protection fittings are also normalized but the choice of construction depends on several factors.

- mechanical influence
- controltechnical parameters like stability,timeconstant,...
- electrical influence
- chemical influence like corrosion,...
- economical considerations

Usually the construction is made this way that the sensor can be changed without disturbing the process.

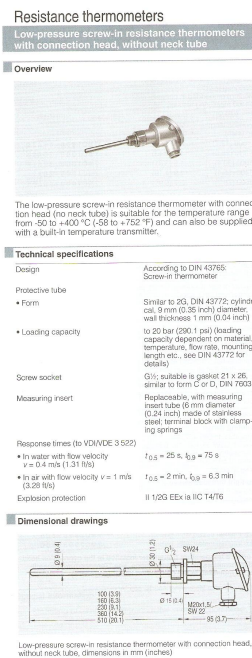

Figure 4: possible design

## 4 Normalisation

RTD are normalised in most industrialised countries. Mostly the german DIN43760 is used for Pt and Ni resistance-temperature sensors. This norm tells that the nominal value of a resistance is  $100\Omega$  at  $0^\circ C$  and a temperature coefficient of  $3,85 \cdot 10^{-3} \text{ }^\circ C^{-1}$ . The normalized temperature range for Pt100 elements is  $-200^\circ C$  to  $850^\circ C$ .

For a Pt100 element the next polynomials are used to describe the relationship between resistance and temperature

1. For the temperature range between  $-200^\circ C \leq t \leq 0^\circ C$

$$R_t = R_0(1 + At + Bt^2 + C(t - 100)t^3)$$

2. For the temperature range between  $0^\circ C \leq t \leq 850^\circ C$

$$R_t = R_0(1 + At + Bt^2)$$

In which

- $A = 3,90802 \cdot 10^{-3} \text{ }^\circ C^{-1}$
- $B = -5,80195 \cdot 10^{-7} \text{ }^\circ C^{-2}$
- $C = -4,2735 \cdot 10^{-12} \text{ }^\circ C^{-4}$

On these resistances tolerances are defined

- class A:  $\Delta t = \pm(0.15^\circ + 0.002|t|)$
- class B:  $\Delta t = \pm(0.3^\circ + 0.005|t|)$

As said in previous paragraph, the protective fitting itself is also normalized and you can find it in DIN43763. There are different classes of protective fitting for example

- Model A: is used in ovens and scavenging channels in which the pressure is low.
- Model B: is used in environments where gas, vapour and fluid are under pressure

There are a lot more models, e.g. Eex proof, but this goes beyond the scope of these notes.

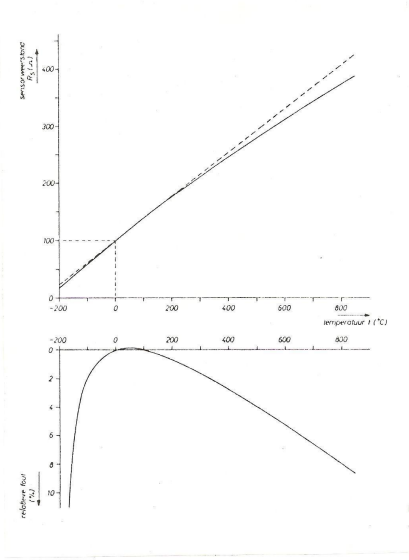

De weerstand van een volgens de DIN43760 genormaliseerd Pt100-element als functie van de temperatuur en de ideale lineaire relatie (a)  
 De relatieve fout is afhankelijk van het meetbereik (b)

Figure 5: relative deviation of measured temperature

## 5 Properties

### 5.1 Stability

One of the most interesting advantages of a resistance thermometer is the good stability over a long period of time.

During testing in special testovens with hot air at temperatures around  $800^{\circ}\text{C}$  with Pt100 elements for more than 10000 hours (for about a year) an unstability of  $\mp 0.2\%$  of the  $0\%$  value was measured. This equals a drift of about  $\mp 0,5\%$  of the measured temperature.

### 5.2 Precision

The absolute stability of this type of sensor is also quite high. Up to  $300^{\circ}\text{C}$  a tolerance of  $\pm 0,75^{\circ}\text{C}$  is applied. At temperatures of  $700^{\circ}\text{C}$  to  $800^{\circ}\text{C}$  a tolerance of  $\pm 1\%$  is applied.



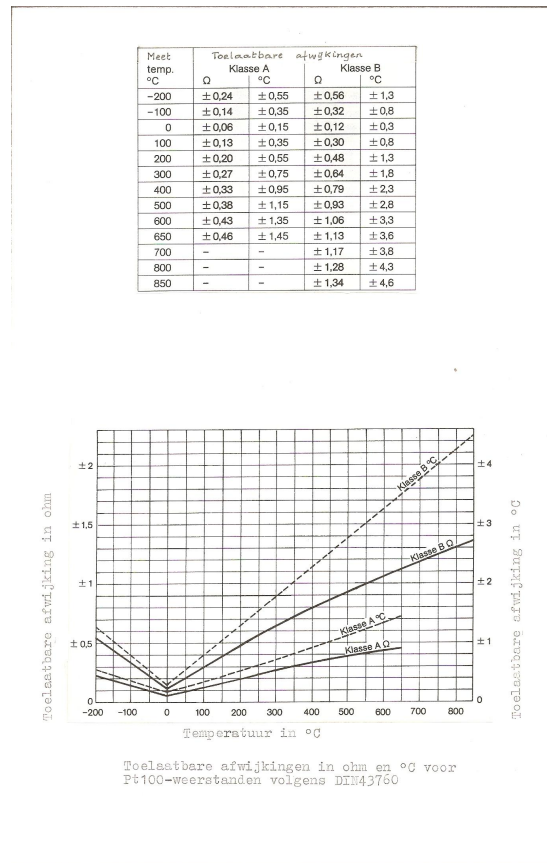

Figure 6: acceptable deviations in Ohm for a Pt100

### 5.3 Autoheating

For measures with extreme precision one has to calculate some autoheating of the resistance.

For example the autoheating of Pt100 elements without protective fitting in running water of  $0.1^{\circ}\text{C}$  will occur at about 50mA for the larger models and at 3mA for the smaller ones. In stagnated air these values drop to a factor 50 less.

This autoheating depends on geometry.

### 5.4 Other properties

The timeconstants of Pt100 elements are usually larger then those of thermocouples.

The measuring surface is larger for metal resistance thermometers then for thermocouples.

Isolation failures have more influence on the measurement in the case of Pt100 elements than in the case of thermocouples.

## 6 Signalconditioning

Measuring a resistance can be done with two major principles

1. Based on Ohm's law  $U = RI$ .

We measure the resistance by measuring the current running through the device and the tension over the resistance

2. based on comparing: compare the resistance with the value of a very accurate resistance

To do this several methods are used but most commonly used is the Wheatstone bridge.

We will not go into all these different possible circuits in these lecture notes.

### 6.1 Basic measurement circuit: Wheatstone bridge

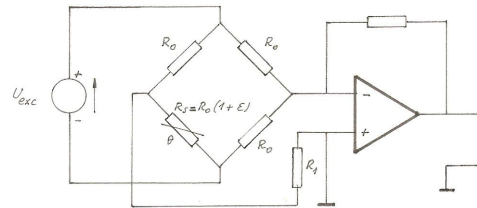

Figure 7: wheatstone bridge with amplification

As we can see in figure 1.7 the basic circuit used is a Wheatstone bridge (in this case with amplification).

In all the calculations that will follow the resistance of the sensor is

$$R_s = R_0(1 + \epsilon)$$

in which  $\epsilon$  is the relative change in resistance. This bridge is in equilibrium if  $R_x = R_0$  and the galvanometer will not register ( $I=0$ ). This means that  $\epsilon = 0$ . If there is a difference in resistance, caused by for example heating, the bridge is out of equilibrium and the galvanometer will register a value different from 0 and this value will be related to the temperature difference.

If we measure a temperature on a remote location we need to transport the information over a certain distance. Crossing this distance we need to boost the

signal because there is always a certain loss of signal during transportation. The first thing to do is amplify the signal.

A second thing to do is make sure that external influences like electric or magnetic fields are compensated. We need to compensate also for autoheating of the circuit and even contactpotentials should be taken under consideration.

Mechanical and chemical influences might even be important enough to be taken care of.

In this section we will look at autoheating compensation and even look at contactpotential compensation.

We need to linearise the circuit because the relation between resistance and temperature is non-linear and also the circuit itself could introduce a non-linearity. This can be done analog as well as digital. In these lecture notes we will not go into this matter.

Another very important problem to take care of is safety. What to do if there is no signal anymore? If there is no detection anymore because of burning of the device or the circuit is cut, you need to have a detection of this malfunction.

## 6.2 Detection of malfunction

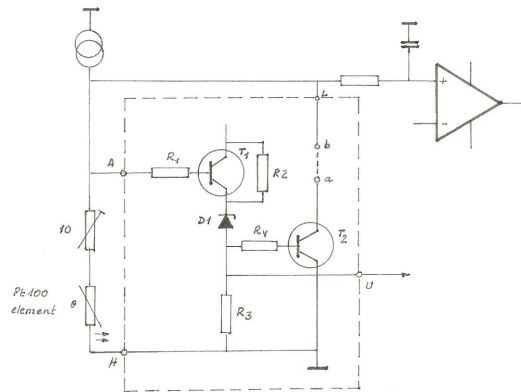

Figure 8: detection circuit in case of malfunction

In figure 1.7 a possible circuit is shown that gives a signal in case a wire of the circuit is cut. In case the measuring circuit is broken transistor  $T1$  and  $T2$  start conducting. If  $T2$  conducts the amplifier is shortcircuited to the ground and the measuring signal takes minimum value.

## 6.3 Compensationcircuits

There are different possibilities to compensate for the problems mentioned above. We will look at some basic circuits.

1. two-wire configuration:only used when high accuracy is not required. By means of a potentiometer the resistance of the wires is compensated. After the compensationthe Pt100 is again connected in the circuit.
2. three-wire configuration:most widely used. Between the first and third connection wire we measure the Pt100 and the resistance of the connectionwire.Between the first and the second we measure the resistance of the conectionwire. If you make the difference of both you have the resistance of the Pt100.
3. four-wire configuration:these are for very high accuracy. Here we take into account the contact resistance of the connections between the wires.Two wires are connected to a source that forces a current of about 1mA through the sensor to avoid autoheating and the two others are used to transfer the measured tension of the Pt100 to the measuring instrument. The high impedance of the measuring instrument allows to neglect potential losses in the circuit.

## 6.4 Two-wire configuration

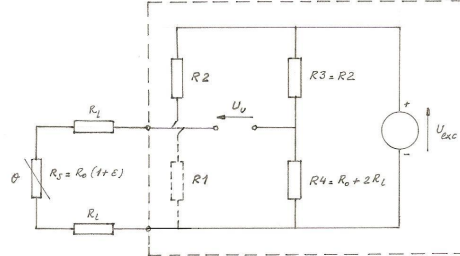

Figure 9: two wire configuration

In a two wire configuration two effects will occur.

- loss of signal
- loss in temperature compensation

The loss in signal as a consequence of the two connection wires can be calculated as follows

$$R_1 = R_s + 2R_l$$

The relative change in resistance will decrease

$$\epsilon_n = \epsilon \frac{R_0}{R_0 + 2R_l}$$

The error due to the resistance of the connection wire is about 1% if  $\frac{R_l}{R_0} \leq 0.005$

This means that for a Pt100 the connection wire has a resistance  $R_l \leq 0.5\Omega$ . For a copper wire with a cross section of  $2.5\text{mm}^2$  this resistance is reached for 71.5m. So to compensate and bring the bridge back into equilibrium by means of a compensation resistance. How is this done

1. temporarily replace the Pt100 by a precision resistance from which the value is known at temperature  $T_0$
2. adjust the compensation resistance so that the indicator shows temperature  $T_0$
3. replace the precision resistance back by the Pt100

## 6.5 Three-wire configuration

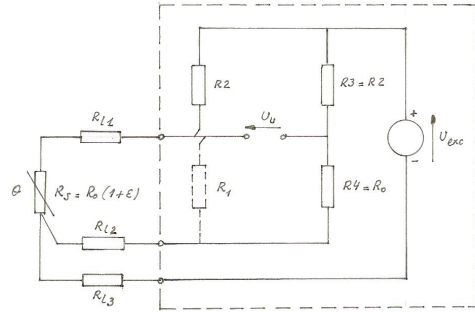

Figure 10: three wire configuration

The undesired effects of connection wire resistance are reduced by this type of configuration. The three wires have an identical resistance. When we measure the tension between  $R_s$  and  $R_4$  and between  $R_2$  and  $R_3$ . Then you subtract the measured tension between  $R_2$  and  $R_3$  from that measured between  $R_s$  and  $R_4$  the measurement has been compensated.

## 6.6 Four-wire configuration

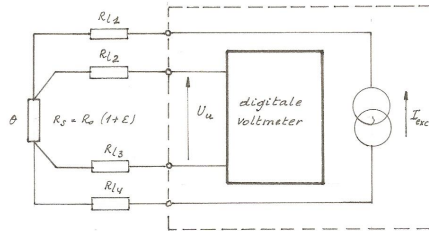

Figure 11: four wire configuration

We won't go into this configuration. Nowadays there are electronic devices build in in the head of the Pt100 that will do the compensation.

## 6.7 Modern communication

The modern way to communicate is by using the so called HARTprotocol(Highway Adressable Remote Transducer). It uses a digital signal modulated over the 4-20mA signal and which can be used to communicate in both directions.

### **6.7.1 Properties**

1. remote diagnosis
2. remote configuration
3. automatic transmission of the status of the instrument
4. automatic transmission of the measuring range of the analog signal
5. primary signal can be transmitted digital as well as analog 4-20mA
6. continuous transmission of a second, third and fourth measurement. (e.g. a coriolis mass flow measurement can also transmit volume flow, density and temperature of the medium).

As treated in chapter 10 of the lecture notes an in-depth study of digital techniques and fieldbus is required to go into this matter.

## 7 Dynamical behavior

The model of this behavior is a first order differential equation that describes the heattransfer between sensor and ambient.

$$q = h.A.(T_0 - T) = m.c.\frac{dT}{dt}$$

where

1.  $q$ =the by convection to the sensor transferred heat
2.  $h$ =convection heat-transfercoefficient
3.  $A$ =surface of the sensor through which the heat runs
4.  $T_0$ =ambient temperature at time  $t_0$
5.  $T$ =temperature of the sensor at  $t_0$
6.  $m$ =mass of the sensor
7.  $c$ =specific heat capacity of the sensor

This equation can be rewritten as

$$\frac{dT}{dt} + \frac{h.A}{m.c}T = \frac{h.A}{m.c}T_0$$

The solution of this differentialequation is considering as initial condition  $T = T_0$

$$T = T_0(1 - e^{-\frac{t}{\beta}})$$

and  $\beta$  is the responsetime of the sensor with

$$\beta = \frac{h.A}{m.c}$$

As a matter of fact the responsetime of the sensor(part of the dead time of the process) is a very important parameter and has to be as low as possible. So we like to have a very fast respons, if we put this otherwise we need the know the temperature in realtime. Tese responstimes depend on the mass of the sensor so designing very light sesors enhances the responstime. A Pt100 has about 0.1 to 1s halflife and thinfilm sensors about 0.05s half life.



Resistance thermometer

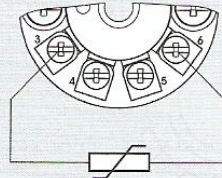

Two-wire system <sup>1)</sup>

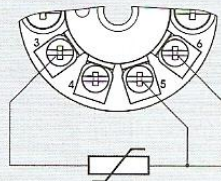

Three-wire system

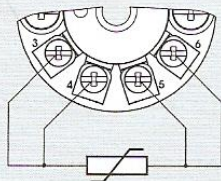

Four-wire system

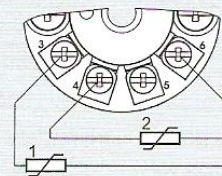

Mean-value/differential or  
redundancy generation  
2 x two-wire system <sup>1)</sup>

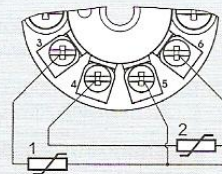

Mean-value/differential or  
redundancy generation  
1 sensor in two-wire system <sup>1)</sup>  
1 sensor in three-wire system

Figure 12: possible connections